

65V N-Ch Power MOSFET
Feature

- ◇ High Speed Power Switching, Logic Level
- ◇ Enhanced Body diode dv/dt capability
- ◇ Enhanced Avalanche Ruggedness
- ◇ 100% UIS Tested, 100% Rg Tested
- ◇ Lead Free, Halogen Free



| | | | |
|-------------------------|---------------|------|------------|
| V_{DS} | | 65 | V |
| $R_{DS(on),typ}$ | $V_{GS}=10V$ | 8.5 | m Ω |
| $R_{DS(on),typ}$ | $V_{GS}=4.5V$ | 12.5 | m Ω |
| I_D (Silicon Limited) | | 13.4 | A |

Application

- ◇ Synchronous Rectification in SMPS
- ◇ Hard Switching and High Speed Circuit
- ◇ DC/DC in Telecoms and Industrial

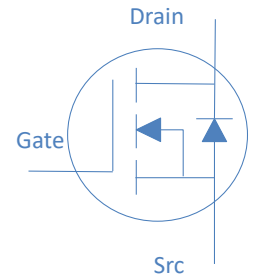
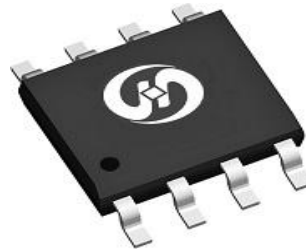
SOIC-8

| Part Number | Package | Marking |
|-------------|---------|------------|
| HGS092NE6AL | SOIC-8 | GS092NE6AL |

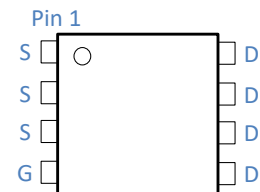
Absolute Maximum Ratings at $T_j=25^{\circ}C$ (unless otherwise specified)

| Parameter | Symbol | Conditions | Value | Unit |
|--|----------------|----------------------------|------------|-------------|
| Continuous Drain Current (Silicon Limited) | I_D | $T_C=25^{\circ}C$ | 13.4 | A |
| | | $T_C=100^{\circ}C$ | 8.5 | |
| Drain to Source Voltage | V_{DS} | - | 65 | V |
| Gate to Source Voltage | V_{GS} | - | ± 20 | V |
| Pulsed Drain Current | I_{DM} | - | 56 | A |
| Avalanche Energy, Single Pulse | E_{AS} | $L=0.4mH, T_C=25^{\circ}C$ | 20 | mJ |
| Power Dissipation | P_D | $T_C=25^{\circ}C$ | 3.1 | W |
| Operating and Storage Temperature | T_J, T_{stg} | - | -55 to 150 | $^{\circ}C$ |

Absolute Maximum Ratings

| Parameter | Symbol | Max | Unit |
|--|-----------------|-----|---------------|
| Thermal Resistance Junction-Lead | $R_{\theta JL}$ | 25 | $^{\circ}C/W$ |
| Thermal Resistance Junction-Ambient ($t \leq 10s$) | $R_{\theta JA}$ | 40 | $^{\circ}C/W$ |
| Thermal Resistance Junction-Ambient (steady state) | | 75 | $^{\circ}C/W$ |

Electrical Characteristics at $T_j=25^\circ\text{C}$ (unless otherwise specified)
Static Characteristics

| Parameter | Symbol | Conditions | Value | | | Unit |
|-----------------------------------|---------------|--|-------|------|-----------|-----------|
| | | | min | typ | max | |
| Drain to Source Breakdown Voltage | $V_{(BR)DSS}$ | $V_{GS}=0V, I_D=250\mu A$ | 65 | - | - | V |
| Gate Threshold Voltage | $V_{GS(th)}$ | $V_{GS}=V_{DS}, I_D=250\mu A$ | 1.0 | 1.7 | 2.4 | |
| Zero Gate Voltage Drain Current | I_{DSS} | $V_{GS}=0V, V_{DS}=60V, T_j=25^\circ\text{C}$ | - | - | 1 | μA |
| | | $V_{GS}=0V, V_{DS}=60V, T_j=100^\circ\text{C}$ | - | - | 100 | |
| Gate to Source Leakage Current | I_{GSS} | $V_{GS}=\pm 20V, V_{DS}=0V$ | - | - | ± 100 | nA |
| Drain to Source on Resistance | $R_{DS(on)}$ | $V_{GS}=10V, I_D=10A$ | - | 8.5 | 10 | $m\Omega$ |
| | $R_{DS(on)}$ | $V_{GS}=4.5V, I_D=5A$ | - | 12.5 | 16 | $m\Omega$ |
| Transconductance | g_{fs} | $V_{DS}=5V, I_D=10A$ | - | 35 | - | S |
| Gate Resistance | R_G | $V_{GS}=0V, V_{DS}$ Open, $f=1\text{MHz}$ | - | 1.75 | - | Ω |

Dynamic Characteristics

| | | | | | | |
|-------------------------------|--------------|---|---|------|---|----|
| Input Capacitance | C_{iss} | $V_{GS}=0V, V_{DS}=30V, f=1\text{MHz}$ | - | 767 | - | pF |
| Output Capacitance | C_{oss} | | - | 261 | - | |
| Reverse Transfer Capacitance | C_{rss} | | - | 25 | - | |
| Total Gate Charge | $Q_g(10V)$ | $V_{DD}=30V, I_D=10A, V_{GS}=10V$ | - | 17.5 | - | nC |
| Total Gate Charge | $Q_g(4.5V)$ | | - | 9.9 | - | |
| Gate to Source Charge | Q_{gs} | | - | 2 | - | |
| Gate to Drain (Miller) Charge | Q_{gd} | | - | 6 | - | |
| Turn on Delay Time | $t_{d(on)}$ | $V_{DD}=30V, I_D=10A, V_{GS}=10V,$ $R_G=10\Omega,$ | - | 8 | - | ns |
| Rise time | t_r | | - | 5 | - | |
| Turn off Delay Time | $t_{d(off)}$ | | - | 20 | - | |
| Fall Time | t_f | | - | 4 | - | |

Reverse Diode Characteristics

| | | | | | | |
|-------------------------|----------|--|---|-----|-----|----|
| Diode Forward Voltage | V_{SD} | $V_{GS}=0V, I_F=20A$ | - | 0.9 | 1.2 | V |
| Reverse Recovery Time | t_{rr} | $V_R=30V, I_F=10A, di_F/dt=100A/\mu s$ | - | 27 | - | ns |
| Reverse Recovery Charge | Q_{rr} | | - | 22 | - | nC |

Fig 1. Typical Output Characteristics

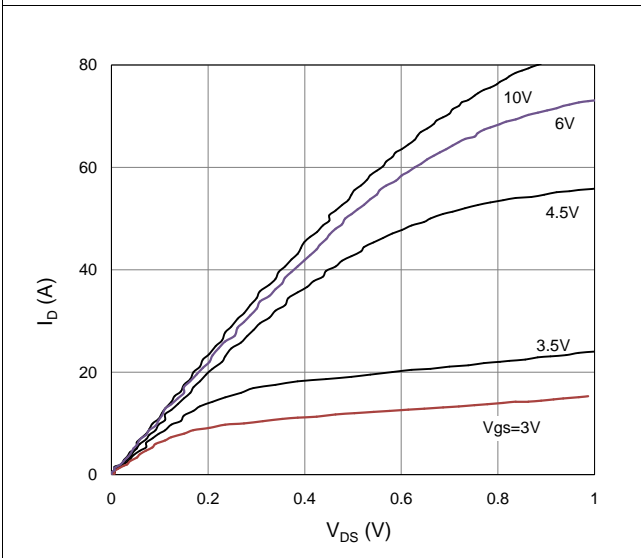

Figure 2. On-Resistance vs. Gate-Source Voltage

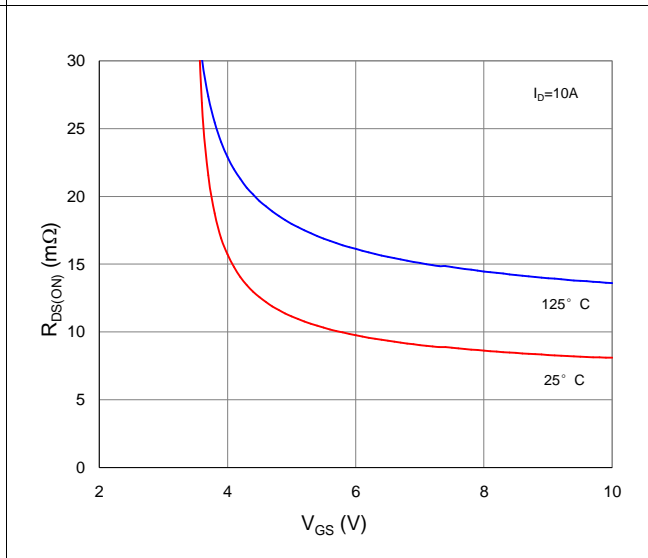

Figure 3. On-Resistance vs. Drain Current and Gate Voltage

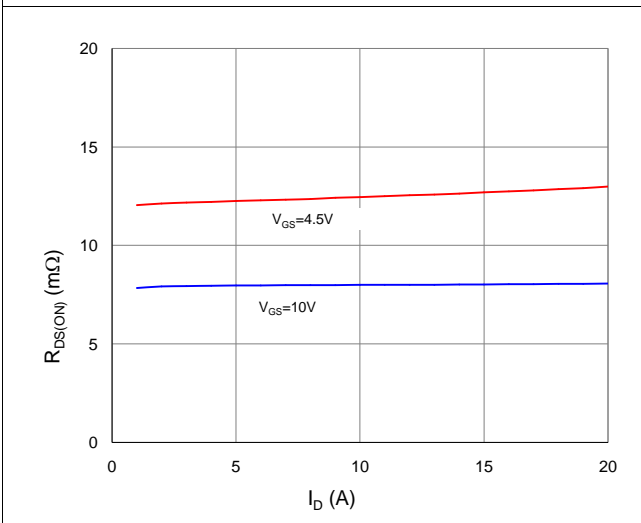

Figure 4. Normalized On-Resistance vs. Junction Temperature

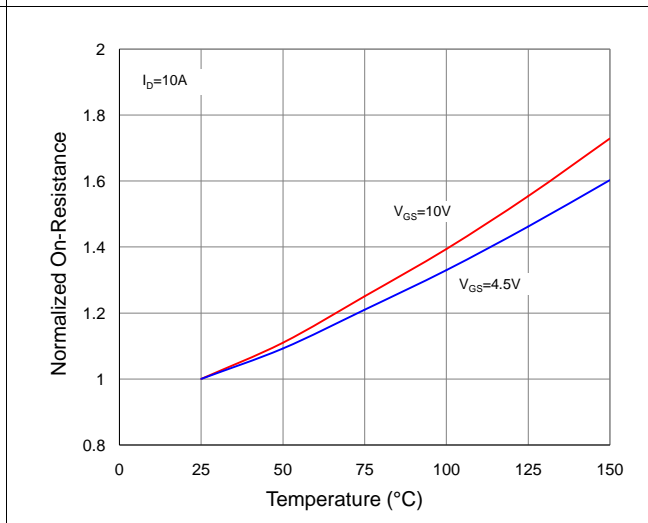

Figure 5. Typical Transfer Characteristics

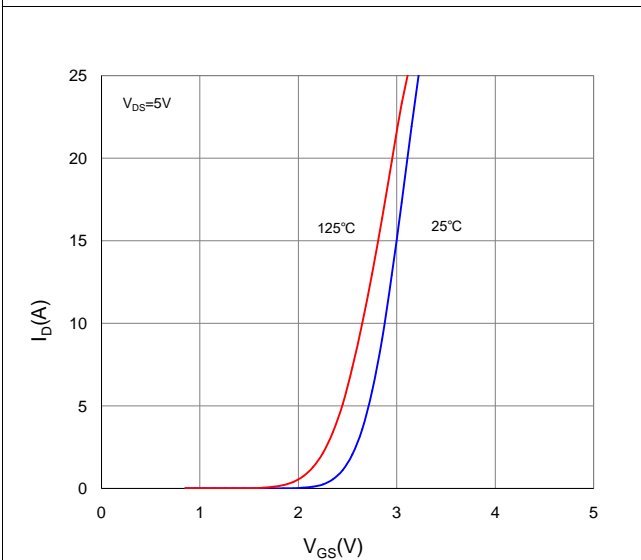

Figure 6. Typical Source-Drain Diode Forward Voltage

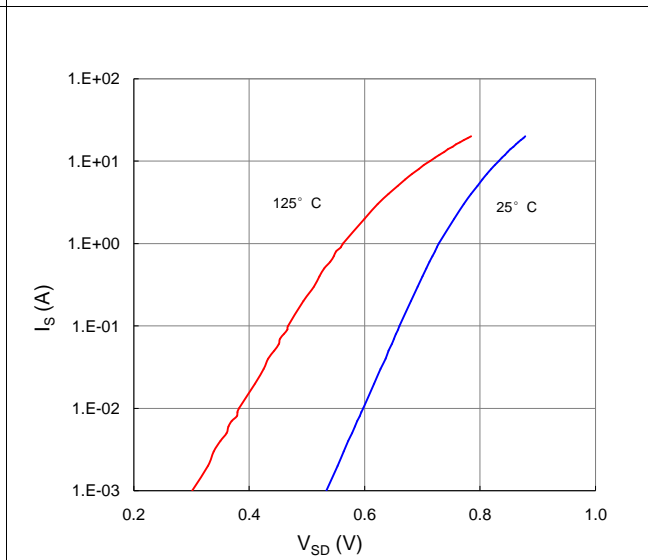

Figure 7. Typical Gate-Charge vs. Gate-to-Source Voltage

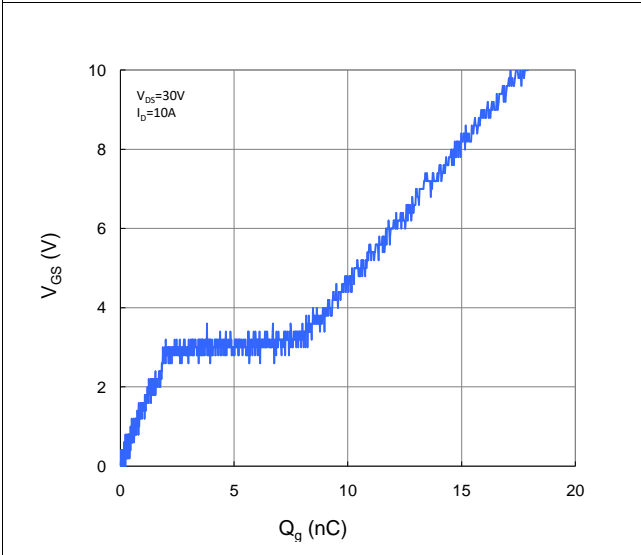

Figure 8. Typical Capacitance vs. Drain-to-Source Voltage

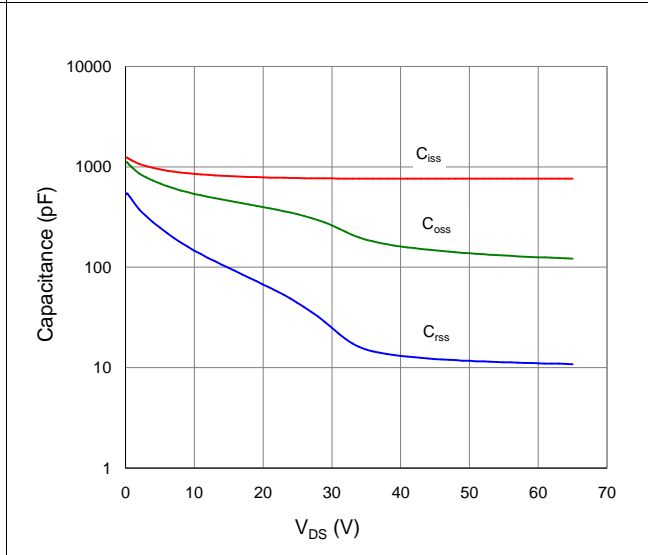

Figure 9. Maximum Safe Operating Area

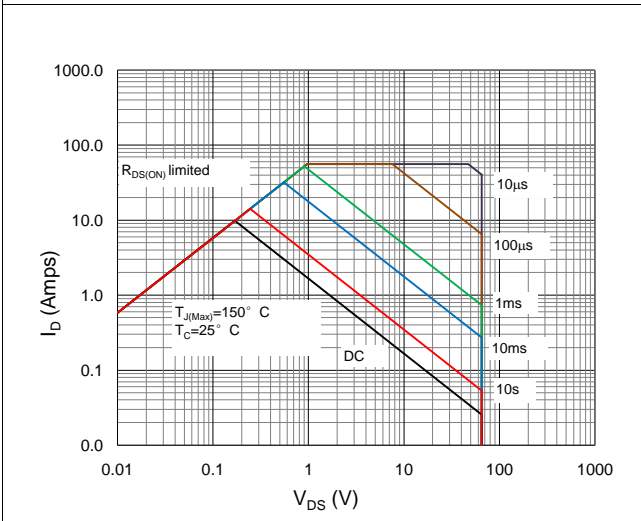

Figure 10. Maximum Drain Current vs. Case Temperature

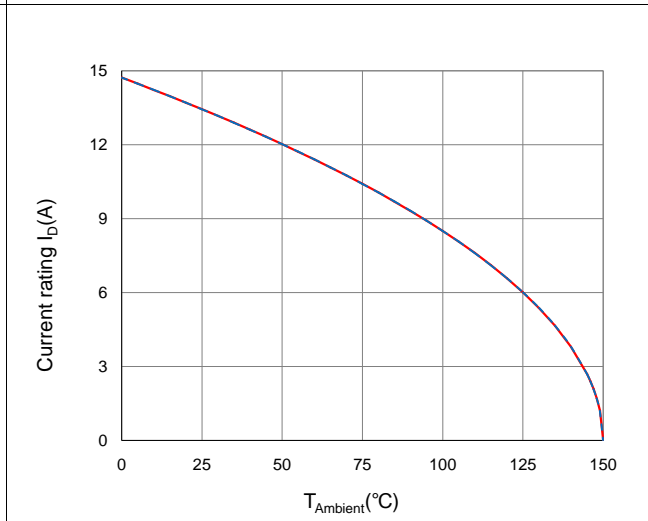
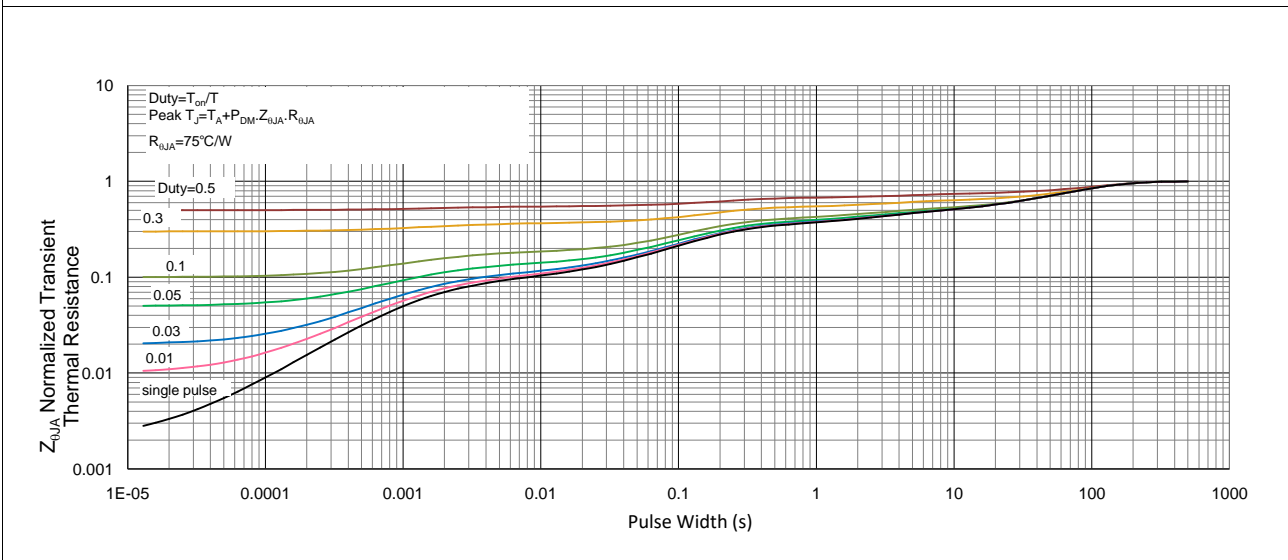
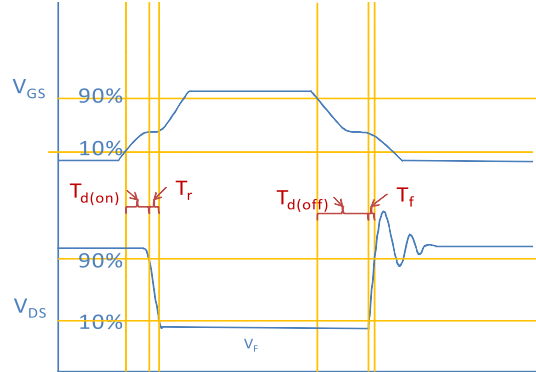
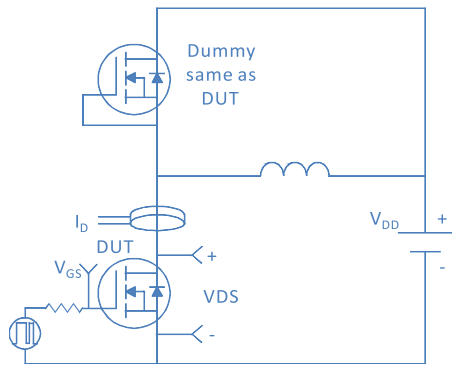

Figure 11. Normalized Maximum Transient Thermal Impedance, Junction-to-Ambient



Inductive switching Test



Gate Charge Test

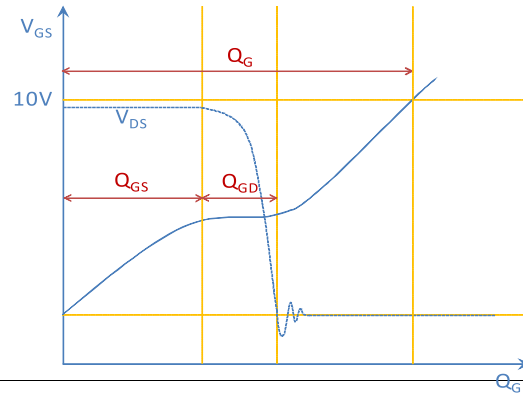
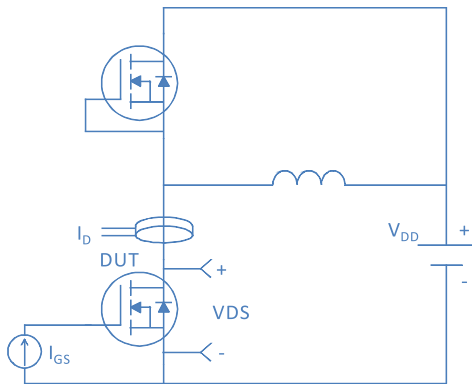

Uclamped Inductive Switching (UIS) Test

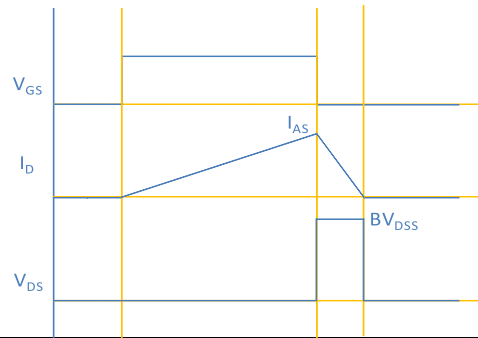
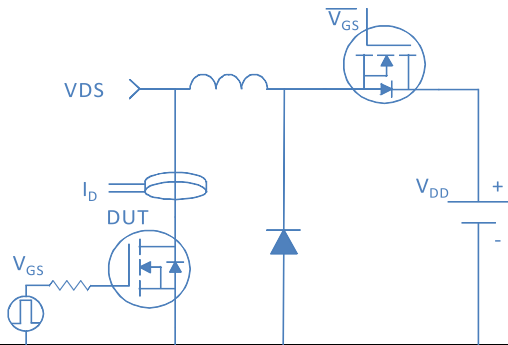

Diode Recovery Test

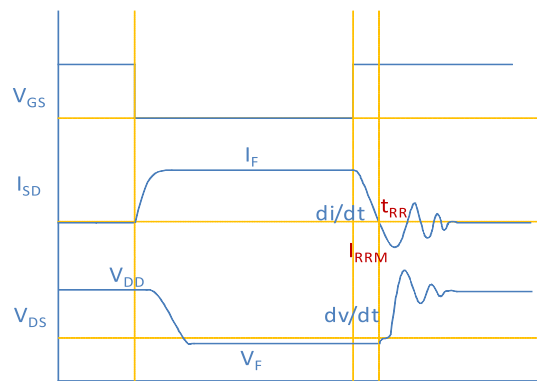
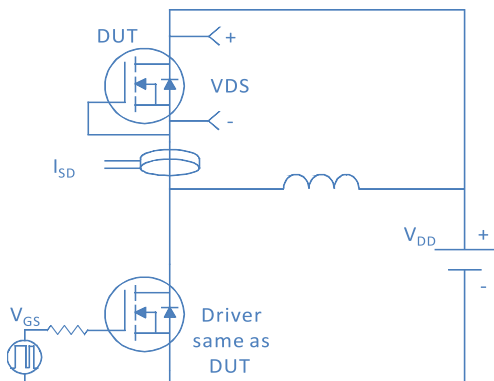

Package Outline

SOIC-8, 8 leads

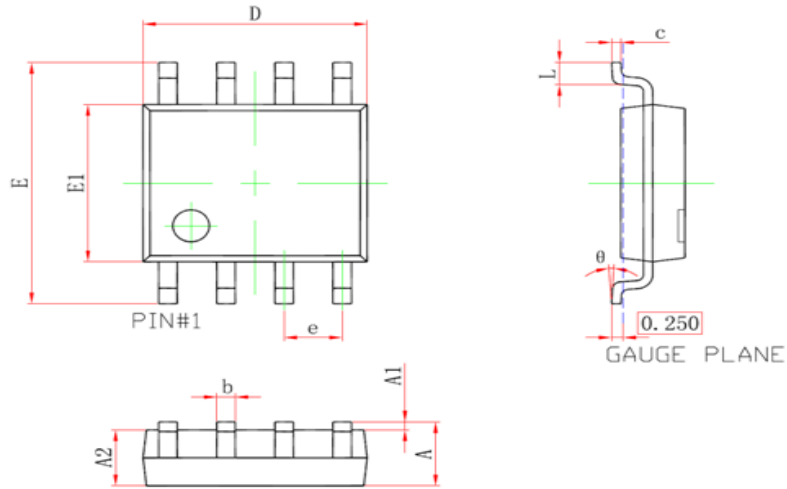

| Symbol | Dimensions In Millimeters | | Dimensions In Inches | |
|--------|---------------------------|-------|----------------------|-------|
| | Min | Max | Min | Max |
| A | 1.350 | 1.750 | 0.053 | 0.069 |
| A1 | 0.100 | 0.250 | 0.004 | 0.010 |
| A2 | 1.250 | 1.650 | 0.049 | 0.065 |
| b | 0.310 | 0.510 | 0.012 | 0.020 |
| c | 0.170 | 0.250 | 0.007 | 0.010 |
| D | 4.800 | 5.000 | 0.189 | 0.197 |
| e | 1.270 (BSC) | | 0.050 (SBC) | |
| E | 5.800 | 6.200 | 0.228 | 0.244 |
| E1 | 3.800 | 4.000 | 0.150 | 0.157 |
| L | 0.400 | 1.270 | 0.016 | 0.031 |
| θ | 0° | 8° | 0° | 8° |